



BSI CYLINDRICAL LOCKSET

Cylindrical locks are widely used in both commercial and residential applications. BSI Cylindrical locks are graded for various applications by ANSI Grade.

5100 SERIES GRADE 1 LEVERSET



GRADE 1



Underwriters Laboratories Inc.®



General Feature

1. 5100 Standard - Certificated by ANSI A156.2-2003.
2. UL listed - Meet UL 3 hours fire rating.
3. 6-Pin cores with the capacity to retrofit all 6-Pin best style locksets.
4. Wide variety of compatible locksets for other famous brands like Schlage, Arrow, Best, Falcon & KSP.
5. Standard Specifications:
 - (1) Lever: zinc, 4 29/32" (125mm) From Lock center to Lever end
 - (2) Rose: Φ 3 17/32" (90mm).
 - (3) Door thickness: 1"-3/8 ~ 2" (35~51mm)
 - (4) Backset: 2 23/64" or 2 3/4" (60mm or 70mm)
 - (5) Concealed Screws: The screws are hidden (concealed), not exposed at exterior side.
6. Clutch Function: The exterior lever have releasing to prevent heavy impact while pressing the lever at locking position.
7. Roller Retractor: The Retractor equipped with roller to enhance the mechanical reliability & durability.
8. Finishes: US26D, US32D

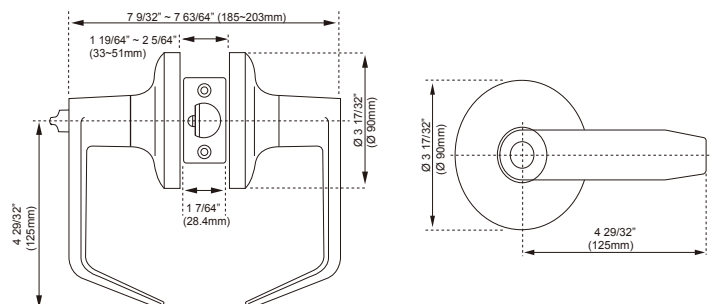

5100 GRADE 1 ELECTRIC LEVERSET



GRADE 1



Underwriters Laboratories Inc.®



5100-S ELECTRIC LOCKSET WITH SOLENOID

STANDARD WIRING
Dual Coil Solenoid

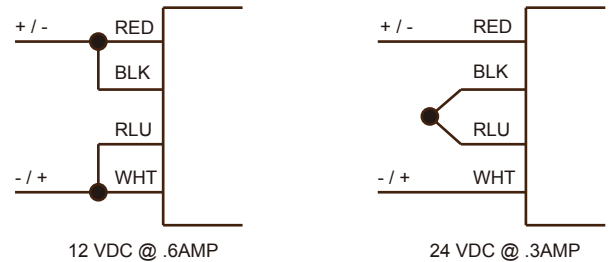

5100-M ELECTRIC LOCKSET WITH MOTOR

MOTOR SPEC. SHEET

No Load		Rated Load		Starting Torque (g-cm)	End Play	Output Shaft	Shaft Direction	Ansi-Static
Speed (r.p.m)	Current (mA)	Speed (r.p.m)	Current (mA)					
16400	<40	12000	<175	>10.5	0.05~0.30	4.0±0.2	CCW	250V 10MΩ

5200 SERIES GRADE 2 LEVERSET



GRADE 2



Underwriters Laboratories Inc.®







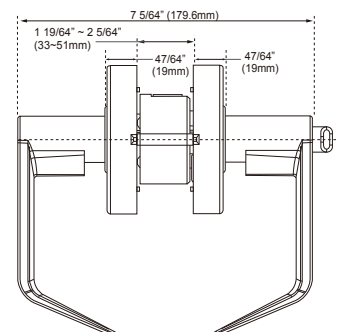
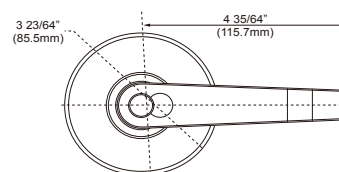

General Feature

- 5200 Standard - Certificated by ANSI A156.2-2003.
- 6-Pin cores with the capacity to retrofit all 6-Pin best style locksets.
- Wide variety of compatible locksets for other famous brands like Schlage, Arrow, Best, Falcon & KSP.
- Standard Specifications:
 - Lever: Zinc, 4 9/16" (116mm) From Lock center to Lever end
 - Rose: Φ 3 11/32" (85mm).
 - Door thickness: 1"-3/8 ~ 2" (35~51mm)
 - Backset: 2 23/64" or 2 3/4" (60mm or 70mm)
 - Concealed Screws: The screws are hidden (concealed), not exposed at exterior side.
 - Clutch function: for outside Lever to prevent damage.
- Inside knob lever is always free to exit.
- The tolerance of each part is very precise, the wavering condition is hardly seen.
- Easy install
- Finishes: US26D, US32D

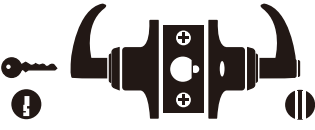
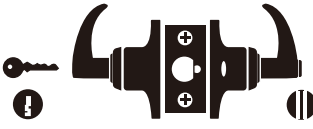

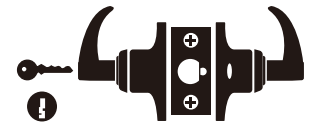
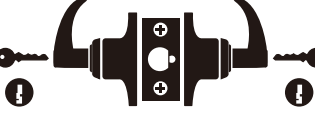

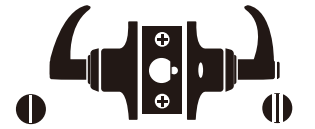
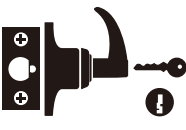
FUNCTION:

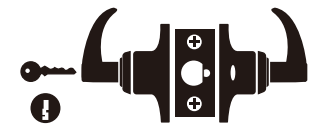
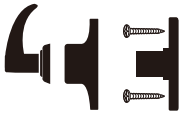
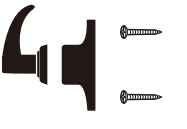
BSI MODEL	ANSI		BSI MODEL	ANSI			
5100FL 5200FL	F109		ENTRANCE/OFFICE LOCK	5101FL 5201FL	F82		ENTRANCE Dead locking latch bolt operated by lever from either side except when outside lever is locked by the push or turn button inside. Key outside or operating inside lever releases push or turn button unlocking outside lever except when push or turn button has been rotated to keep outside lever locked. Inside push or turn button must be manually operated to unlock outside lever. Inside lever always operates latch bolt.
5102FL 5202FL	F90		CORRIDOR LOCK	5111FL 5211FL	F91		DOUBLE CYLINDER LOCK Dead locking latch bolt operated by lever from either side except when both levers are locked by turning key from either side. Latch bolt is automatically dead locked when door is closed.
5112FL 5212FL	F84		CLASSROOM LOCK	5114FL 5214FL	F80		COMMUNICATING LOCK Dead locking latch bolt operated by lever from either side. Turning key in either lever locks or unlocks its own lever independently.
5115FL 5215FL	F110		INTRUDER CLASSROOM LOCK	5130FL 5230FL	F76		PRIVACY LOCK Latch bolt operated by lever from either side. Outside lever is locked by push button or other locking device inside and unlocked by emergency release outside, operating inside lever or closing door.
5151FL 5251FL	F113		COMMUNICATING (KEY TYPE) LOCK	5152FL 5252FL	F111		COMMUNICATING (NON-KEY TYPE) LOCK Locks or unlocks by key from inside only. Outside is a blank plate only.
5161FL 5261FL	F87		DOUBLE STOREROOM LOCK (NON - CLUTCH)	5162FL 5262FL	F86		STOREROOM LOCK Dead locking latch bolt operated by key in levers, from either side. Both levers always inoperable.
5178FL 5278FL			SINGLE DUMMY TRIM	5279FL			SINGLE DUMMY TRIM Dummy trim for one side of door. Used for door pull or as matching inactive trim. Lever and rose attached by two wood screws.



FUNCTION:

BSI MODEL	ANSI		BSI MODEL	ANSI	
5182FL 5282FL	F75	PASSAGE Latch retracted by knobs/levers at all times	5190FL	F77	PATIO LOCK Dead locking latch bolt operated by lever from either side. Outside lever is locked by push button or other locking device inside and unlocked by operating inside lever or closing door.

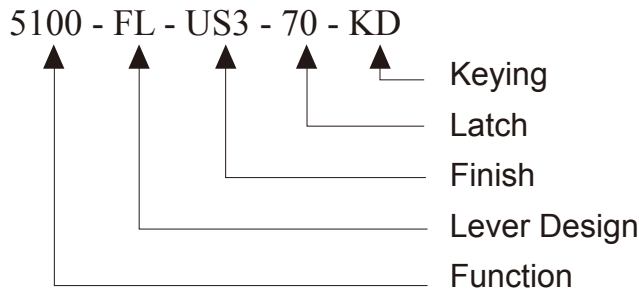

Trim Type	FL - Flat Lever CL - Curve Lever KB - Knob
Latch	60 or 70mm Backset
Keying	KA, KD, CK, MCK MK, GMK, GGMK

EXPLODED VIEW:

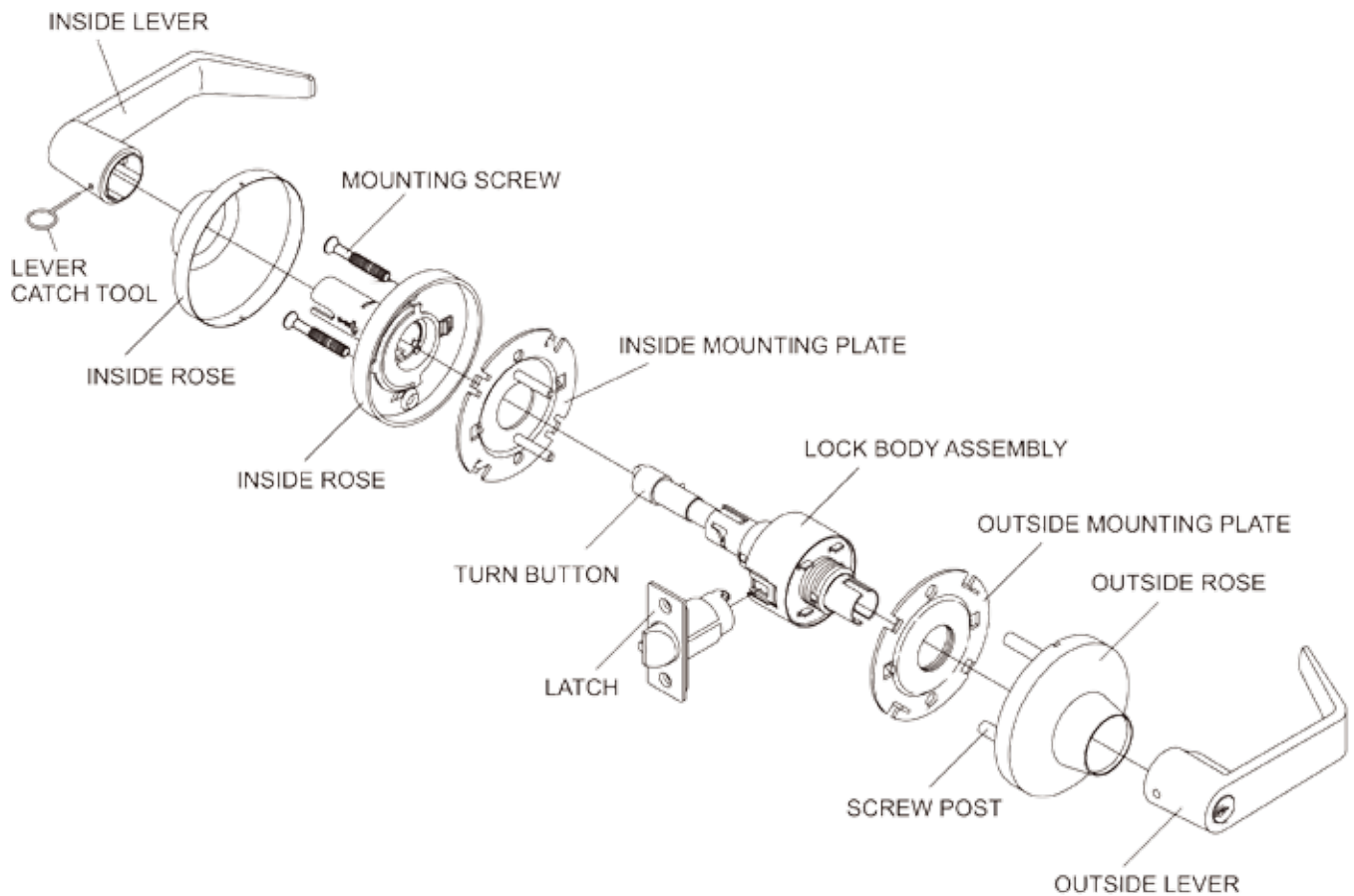

BSI AGENT



BSI Security Co., Ltd.

E-MAIL: sales@bsi-hardware.com

WEBSITE: www.bsi-hardware.com